

# PHYSICSBOWL 2019

March 27 – April 12, 2019

40 QUESTIONS – 45 MINUTES

The sponsors of the 2019 PhysicsBowl, including the **American Association of Physics Teachers**, are providing some of the prizes to recognize outstanding high school physics students and their teachers through their performance on this year's contest.

- Schools compete in one of two divisions, each with nineteen regions.
  - *Division 1* is for students *taking physics for the first time* (even if that first course is AP Physics).
  - *Division 2* is for students taking a second (or more) course in physics OR anyone wanting a challenge.
- A school's team score in each division is the sum of the five highest student scores in that division.
- A school may compete in either or both divisions.

## INSTRUCTIONS

**Answer sheet:** Write and bubble-in the following **REQUIRED** information on your answer sheet:

- Your Name
- Your Teacher's AAPT Teacher code (given to you by your teacher – only **one** code per school!)
- Your Region (given to you by your teacher)
- Your Division (1 for first-year physics students, 2 for students in a 2<sup>nd</sup> physics course OR wanting a challenge)

If this information is not properly bubbled, **you will be disqualified**, as your official score will be a zero.

Your School's CEEB code (given to you by your teacher), though not required, is helpful in the event of a disqualification for identifying your school.

Your answer sheet will be machine graded. Be sure to use a #2 pencil, fill the bubbles completely, and make no stray marks on the answer sheet.

**Questions:** The test is composed of 50 questions; however, students answer only 40 questions. Answers should be marked on the answer sheet next to the number corresponding to the question number on the test.

**Division 1 students will answer only questions 1 – 40.** Numbers 41 – 100 on the answer sheet should remain blank for all Division 1 students.

**Division 2 students will answer only questions 11 – 50.** Numbers 1 – 10 and 51 – 100 on the answer sheet should remain blank for all Division 2 students.

**Calculator:** A hand-held calculator may be used. Any memory must be cleared of data and programs. Calculators may not be shared.

**Formulas and constants:** Only the formulas and constants provided with the contest may be used.

**Time limit:** 45 minutes.

**Score:** Your score is equal to the number of correct answers (no deduction for incorrect answers). If there are tie scores, the entries will be compared from the end of the test forward until the tie is resolved. Thus, the answers to the last few questions may be important in determining the winner and you should consider them carefully.

**Good Luck!**

Copyright © 2019, AAPT

**DIVISION 1  
STUDENTS**

**START HERE.**

**DIVISION 2  
STUDENTS**

Go to question #11  
on page 4.

**Treat  $g = 10.0 \frac{m}{s^2}$  for ALL questions.**

- Select the smallest value from the choices below  
(A)  $15 \times 10^{-3}$       (B)  $0.15 \times 10^0$       (C)  $0.00015 \times 10^3$       (D)  $150 \times 10^{-3}$       (E)  $0.00000015 \times 10^6$
- Related to the historical development of understanding gravity, which is the proper chronological order for the work of these three scientists, from earliest to latest?  
(A) Cavendish, Galileo, Newton  
(B) Galileo, Cavendish, Newton  
(C) Galileo, Newton, Cavendish  
(D) Newton, Galileo, Cavendish  
(E) Newton, Cavendish, Galileo
- An isolated solid metal sphere with a radius  $R$  is given a positive charge  $Q$ . The electric potential at the surface of the sphere is  $V$ . What is the electric potential at a distance of  $0.5R$  from the center of the sphere?  
(A) zero      (B)  $0.5V$       (C)  $V$       (D)  $2V$       (E)  $4V$
- Consider a situation where the acceleration of an object is always directed perpendicular to its velocity. This means that  
(A) the object is increasing speed.  
(B) the object is decreasing speed.  
(C) the object is not moving.  
(D) the object is turning.  
(E) this situation would not be physically possible.
- The acceleration due to gravity on the Moon is less than the acceleration due to gravity on the Earth. Which of the following is true about the mass and weight of an astronaut on the Moon's surface, compared to Earth?  
(A) Mass is less, weight is the same.  
(B) Mass is the same, weight is less.  
(C) Both mass and weight are less.  
(D) Both mass and weight are the same.  
(E) Mass is more, weight is less
- Which one of the following is not equivalent to 2.50 miles?  
(1.00 mi = 1.61 km = 5280 ft, 1.00 yd = 3.00 ft = 12.0 in.)  
(A)  $1.32 \times 10^4$  ft      (B)  $1.58 \times 10^5$  in      (C)  $4.02 \times 10^3$  km      (D)  $4.40 \times 10^3$  yd      (E)  $4.02 \times 10^5$  cm

7. A 100 kg person travels from sea level to an altitude of 5000 m. By how many Newtons does their weight change?  
(A) 0.8 N                      (B) 1.2 N                      (C) 1.6 N                      (D) 2.0 N                      (E) 2.4 N
8. A candle, a converging lens and a white screen are placed in a line with the lens between the candle and the screen. A distance of 72 cm separates the candle and screen. As the lens is moved to all points between the candle and the screen, only one focused image of the candle can be made on the screen. What is the focal length of the converging lens?  
(A) 12 cm  
(B) 18 cm  
(C) 24 cm  
(D) 36 cm  
(E) It cannot be determined without knowing the location of the lens when the focused image is produced.
9. Standby power (sometimes called vampire power) is the power used by a device that is off but plugged in and in a standby mode. Regulations typically limit this power to 1 Watt. If electricity costs \$0.10 per kilowatt hour, then to the nearest order of magnitude, and assuming 1 Watt, how much does it cost to leave a device in standby mode for one year?  
(A) \$0.01                      (B) \$0.10                      (C) \$1.00                      (D) \$10.00                      (E) \$100.00
10. A student generates a transverse periodic wave on a string. The wave travels away from the student at a constant speed  $v$ . Which of the following changes by itself will increase the speed at which the wave travels away from the student?  
(A) The student could use the same string but increase the frequency at which they generate the wave.  
(B) The student could use the same string but increase the wavelength of the waves they generate.  
(C) The student could use the same string but increase the amplitude of the waves they generate.  
(D) The student could use a string with the same length and tension, but greater linear density  
(E) The student could use the same string, but placed under greater tension.

**DIVISION 1  
STUDENTS**

**Continue**  
Answer questions #11  
through #40.

**DIVISION 2 STUDENTS**

**START HERE**  
Numbers 1 – 10 on your answer sheet  
should be blank. Your first answer  
should be for #11.

**Treat  $g = 10.0 \frac{m}{s^2}$  for ALL questions.**

11. You throw a ball at angle  $\theta$ , and measure its horizontal range,  $R$ . You now throw the same ball again at the same angle, but with twice the original speed. Its horizontal range, compared to your first throw (in both cases, the ball lands at the same height from which it was thrown) would be
- (A)  $1.4R$   
(B)  $0.5R$   
(C)  $2R$   
(D)  $4R$   
(E) the same

12. A horizontal disk has a spring and a mass attached to a rod passing through its center. The spring has a spring constant of  $k$  and the attached mass is  $m$ . When the disk is not rotating, the equilibrium length of the spring is  $d$ . The disk is now angularly accelerated until it reaches a constant angular velocity of  $\omega$ . At this angular velocity the length of the spring is now  $2d$ . What is the angular velocity of the disk?

- (A)  $\sqrt{\frac{k}{d}}$     (B)  $\sqrt{\frac{k}{2m}}$     (C)  $\sqrt{\frac{2k}{m}}$     (D)  $\sqrt{\frac{2d}{k}}$     (E)  $\sqrt{\frac{d}{2k}}$

TOP VIEW

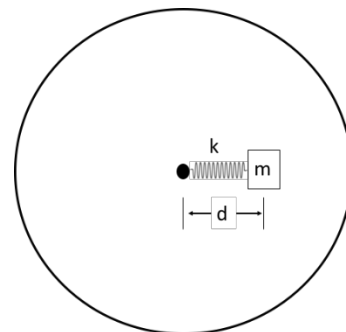

13. You measure that 4000 kcal of heat conducts through a window in your house in one hour when the house is kept at  $20^\circ\text{C}$ . The window is a  $4.0 \text{ m}^2$  pane of  $0.30 \text{ cm}$  thick glass ( $k = 2.0 \times 10^{-4} \text{ kcal/s}\cdot\text{m}\cdot\text{C}^\circ$ ). What is the outside temperature?
- (A)  $4^\circ\text{C}$     (B)  $8^\circ\text{C}$     (C)  $13^\circ\text{C}$     (D)  $16^\circ\text{C}$     (E)  $18^\circ\text{C}$
14. The red glow in the neon tube of an advertising sign is a result of
- (A) fluorescence    (B) incandescence    (C) iridescence    (D) coherence    (E) de-excitation
15. Which of the following people was a recipient of the 2018 Nobel Prize in Physics?
- (A) Frances Arnold  
(B) Donna Strickland  
(C) Tasuku Honjo  
(D) Kip Thorne  
(E) Joachim Frank

16. Water flows out of a horizontal drainpipe at the rate of 120 kg per minute. Its initial vertical velocity is zero and it falls 3.20 m to the ground. What is the average force it exerts when it hits the ground?  
 (A) 6.0 N            (B) 10.0 N            (C) 12.0 N            (D) 16.0 N            (E) 20.0 N

17. A sphere has a radius of  $1.96 \pm 0.01$  m. What is the approximate uncertainty in its volume?  
 (A)  $31.5 \pm 0.2$  m<sup>3</sup>    (B)  $31.5 \pm 0.3$  m<sup>3</sup>    (C)  $31.5 \pm 0.4$  m<sup>3</sup>    (D)  $31.5 \pm 0.5$  m<sup>3</sup>    (E)  $31.5 \pm 0.6$  m<sup>3</sup>

18. A block slides up and back down a rough incline. Which of the following graphs could represent the velocity of the block as a function of time? All graphs use the same scale and uphill as the positive direction.

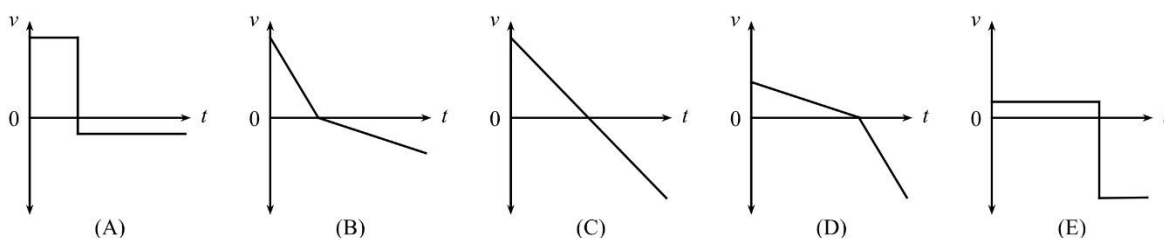

19. A ball with a mass of 0.500 kg traveling at 4.80 m/s strikes a wall and rebounds in the opposite direction at 3.60 m/s. What is the magnitude of the impulse that acted on the ball during the collision with the wall?

- (A) 0.600 N·s  
 (B) 1.20 N·s  
 (C) 2.70 N·s  
 (D) 4.20 N·s  
 (E) 16.8 N·s

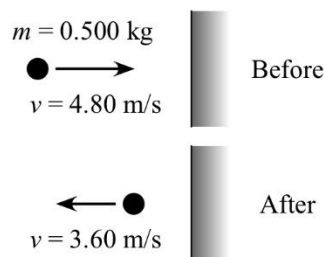

20. A string, fixed at both ends, vibrates at a frequency of 12 Hz with a standing transverse wave pattern containing 3 loops (antinodes). What frequency is needed if the standing wave pattern is to contain 4 loops (antinodes)?

- (A) 12 Hz            (B) 16 Hz            (C) 36 Hz            (D) 48 Hz            (E) 60 Hz

21. Let  $M$  represent the magnification of an image. For which of the following arrangements of an object and an optical device would  $-1 < M < 0$ ?

- (A) The object is placed less than one focal length in front of a converging mirror.  
 (B) The object is placed between one focal length and two focal lengths in front of a diverging mirror.  
 (C) The object is placed less than one focal length in front of a diverging lens.  
 (D) The object is placed more than two focal lengths in front of a converging lens.  
 (E) The object is placed between one focal length and two focal lengths in front of a plane mirror.

22. An Atwood machine is shown in the diagram at the right with  $m_1=0.60$  kg and  $m_2=0.40$  kg. What is the magnitude of the acceleration of  $m_2$ ? Ignore friction and the mass of the pulley.
- (A)  $4.2 \text{ m/s}^2$   
 (B)  $3.3 \text{ m/s}^2$   
 (C)  $2.0 \text{ m/s}^2$   
 (D)  $5.0 \text{ m/s}^2$   
 (E)  $1.0 \text{ m/s}^2$

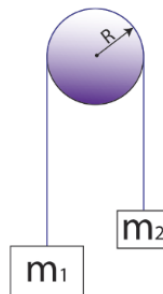

23. A 30.0-N block falls straight down from a height of 10.0 m, and strikes the ground with a velocity of 7.00 m/s. What average force of air friction acts on it as it falls?
- (A) 22.65-N      (B) 45.45-N      (C) 75.0-N      (D) 206.5-N      (E) 293-N

**Questions 24 & 25 refer to Circuit 1.**

24. The capacitor is initially uncharged. Which of the following choices best represents the current at Point X immediately after the switch is closed?
- (A) Zero  
 (B) 24 mA directed to the right  
 (C) 36 mA directed to the left  
 (D) 48 mA directed to the left  
 (E) 72 mA directed to the right

Circuit 1

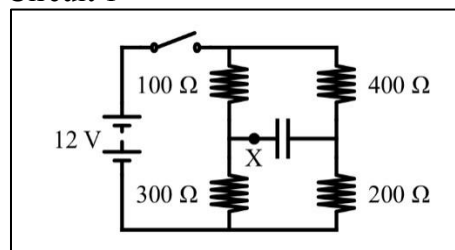

25. If the capacitor has a capacitance of  $15 \mu\text{F}$  and is uncharged prior to closing the switch, what is the steady-state charge on the capacitor?
- (A)  $3 \mu\text{C}$       (B)  $45 \mu\text{C}$       (C)  $75 \mu\text{C}$       (D)  $90 \mu\text{C}$       (E)  $120 \mu\text{C}$
26. A 15.0-mW laser emits a beam that is 2.00 mm in diameter. What is the intensity of this beam?
- (A)  $1.19 \times 10^3 \text{ W/m}^2$   
 (B)  $1.19 \times 10^4 \text{ W/m}^2$   
 (C)  $3.59 \times 10^4 \text{ W/m}^2$   
 (D)  $4.77 \times 10^4 \text{ W/m}^2$   
 (E)  $2.98 \times 10^5 \text{ W/m}^2$
27. The unit that is used to measure magnetic flux is:
- (A) Coulomb (C)      (B) Farad (F)      (C) Tesla (T)      (D) Weber (Wb)      (E) Henry (H)
28. A curve on a racetrack has a radius of 80 m and is banked at  $45^\circ$ . Suppose that the road surface on the curve somehow became frictionless (perhaps caused by an ice storm or an oil spill) and a car needs to navigate this curve. What is the safe speed with which to take the curve without either sliding up or down the bank of the curve?
- (A) 9 m/s      (B) 14 m/s      (C) 21 m/s      (D) 28 m/s      (E) 33 m/s
29. A convex lens has a focal length of 50 mm. How far from the lens must an object be placed if it is to form a virtual image magnified in size by a factor of three?
- (A) 33 mm      (B) 38 mm      (C) 43 mm      (D) 48 mm      (E) 53 mm

30. Consider the bicycle wheel shown at the right to be a ring with a 60 cm diameter and a mass of 1.5 kg. Attached to the wheel is a gear with a radius of 4.0 cm and negligible mass. A force of 20 N is applied tangentially to the gear for 4.0 s. Starting from rest, what linear speed does the wheel achieve, assuming it rolls without slipping?



- (A) 3.0 m/s  
 (B) 5.9 m/s  
 (C) 7.1 m/s  
 (D) 16.4 m/s  
 (E) 24 m/s

31. The intensity level is measured to be 60 dB at a distance of 15 m from a speaker. What is the intensity level at a point 2.0 m from the speaker? Assume that the speaker radiates equally in all directions
- (A) 55.7 dB      (B) 57.5 dB      (C) 67.0 dB      (D) 75.5 dB      (E) 77.5 dB

32. A pine wood block is floating in a small pool. There is a second pine wood block that sits on top of the first and does not touch the water. If the top block is taken off and placed in the water, how does the new water level in the pool compare to the original water level?
- (A) Rises  
 (B) Lowers  
 (C) Does not change  
 (D) It depends upon the size of the blocks  
 (E) It depends upon the amount of water in the pool.

33. Two cars are being tested on a track. *Car 1* accelerates from rest on this straight track at  $a_1=3.0\text{m/s}^2$ . Two seconds later, *Car 2* accelerates from rest at  $a_2=12.0\text{ m/s}^2$ . How much time after *Car 1* starts will *Car 2* pass *Car 1*?
- (A) 3.0 s      (B) 4.0 s      (C) 5.0 s      (D) 6.0 s      (E) 7.0 s

34. The table at right lists the finish times for the 2008 Men's Olympic 100 m butterfly swim final in Beijing. From the data, what is the best estimate of the distance the 2<sup>nd</sup> place finisher, Cavic, was behind the 1<sup>st</sup> place finisher, Phelps?
- (A) 0.2 cm  
 (B) 2.0 cm  
 (C) 5.0 cm  
 (D) 10 cm  
 (E) 20 cm

100 m Men's Butterfly Swim		
1	Michael Phelps	50.58 s
2	Milorad Cavic	50.59 s
3	Andrew Lauterstein	51.12 s
4	Ian Crocker	51.13 s
5	Jason Dunford	51.47 s
6	Takuro Fujii	51.50 s
7	Andrii Serdinov	51.59 s
8	Ryan Pini	51.86 s

35. In a mixture of hydrogen, oxygen, and nitrogen gases at room temperature, the molecules having the greatest average speed are those of
- (A) Hydrogen  
 (B) Oxygen  
 (C) Nitrogen  
 (D) All have the same speed  
 (E) It depends upon the composition of the mixture

**Questions 36 & 37 refer to Circuit 2. The battery is assumed ideal with an emf of 3.0 V**

36. The resistor that dissipates the most power is:

- (A)  $R_1$
- (B)  $R_2$
- (C)  $R_3$
- (D)  $R_4$
- (E)  $R_5$

37. The voltage across resistor  $R_4$  is:

- (A) 0.4 V
- (B) 0.6 V
- (C) 1.2 V
- (D) 1.5 V
- (E) 3.0 V

Circuit 2

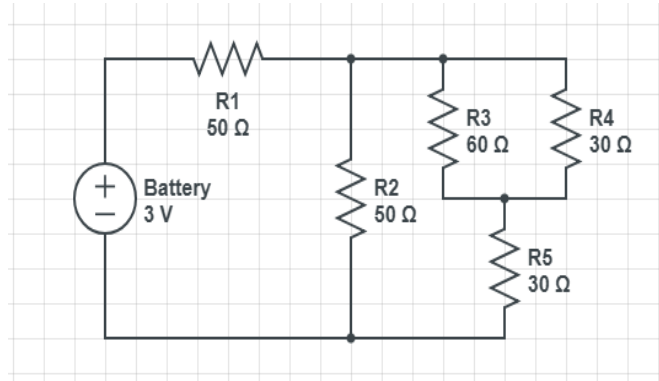

38. Shown here is accelerometer data for an elevator ride in a skyscraper in Chicago. The spikes at roughly 10s and 72s are caused by the handling of the accelerometer which rested on the floor of the elevator and occurred before the elevator started moving up, and after it reached the top, respectively. What is the best estimate for the peak vertical speed for this elevator

- (A) 4 m/s
- (B) 8 m/s
- (C) 12 m/s
- (D) 16 m/s
- (E) 20 m/s

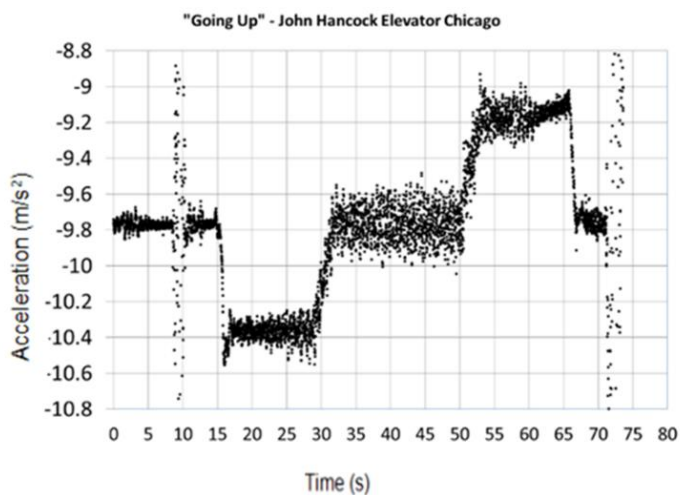

39. The picture shows two speakers,  $A$  and  $B$ , which emit the same 680-Hz tones in phase. Point  $P$  is located 1.000 m directly in front of *Speaker A*. A sound sensor at Point  $P$  records a minimum sound intensity. *Speaker B* is slowly moved away from *Speaker A* along the line joining them. How far must *Speaker B* be moved further from *Speaker A* until the sound sensor at Point  $P$  first records a maximum sound intensity?

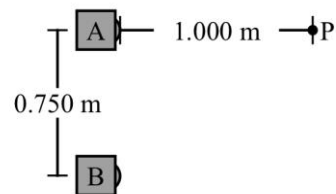

- (A) 0.368 m
- (B) 0.438 m
- (C) 0.500 m
- (D) 0.686 m
- (E) 0.982 m

40. The bulb of a mercury thermometer has a volume of  $0.100 \text{ cm}^3$  at  $10^\circ\text{C}$  and contains  $0.100 \text{ cm}^3$  of mercury. The capillary tube above the bulb has a cross-sectional area of  $0.012 \text{ mm}^2$ . The volume thermal expansion coefficient of mercury is  $1.8 \times 10^{-4} (\text{C}^\circ)^{-1}$ . How much will the mercury rise when the temperature rises by  $30 \text{ C}^\circ$  (the expansion of the glass is negligible)?

- (A) 0.045 mm
- (B) 0.45 mm
- (C) 4.5 mm
- (D) 45 mm
- (E) 45 cm



**DIVISION 1  
STUDENTS**

**STOP HERE**

Your last answer should be for #40. Numbers 41-50 should remain blank for Division 1 students.

**DIVISION 2  
STUDENTS**

**CONTINUE**

Answer questions #41 through #50.

Treat  $g = 10.0 \frac{m}{s^2}$  for ALL questions.

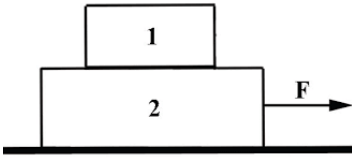
41. To monitor the breathing of a hospital patient, a thin belt is wrapped around a patient's chest and back. The belt is a 200 turn coil of conducting wire. When the patient inhales, the area of the coil increases by  $39.0 \text{ cm}^2$ . The magnitude of the Earth's magnetic field is  $50.0 \mu\text{T}$  and makes an angle of  $28.0^\circ$  to the plane of the coil. Assuming the patient takes  $1.80 \text{ s}$  to inhale, how much *emf* is induced in the coil?  
(A)  $1.91 \times 10^{-5} \text{ V}$     (B)  $9.57 \times 10^{-8} \text{ V}$     (C)  $9.57 \times 10^{-4} \text{ V}$     (D)  $1.02 \times 10^{-5} \text{ V}$     (E)  $3.44 \times 10^{-5} \text{ V}$
42. Three identical samples of a monatomic ideal gas are taken from a temperature  $T$  to a temperature  $2T$ . Sample A undergoes an adiabatic process. Sample B undergoes an isobaric process and Sample C undergoes an isochoric process. Which of the following correctly ranks the heats added to the samples during the three processes?  
(A)  $Q_A < Q_B < Q_C$   
(B)  $Q_A < Q_C < Q_B$   
(C)  $Q_B < Q_A < Q_C$   
(D)  $Q_C < Q_A < Q_B$   
(E)  $Q_C < Q_B < Q_A$
43. Two boxes are stacked on a table as shown at right. The mass of box 1 is  $m$  and the mass of box 2 is  $3m$ . The surface between box 2 and the table is smooth and the surface between the two boxes is rough. When a force,  $F$ , is applied, box 1 does not slide on box 2. What is the minimum coefficient of static friction between the boxes?  
(A)  $\frac{F}{4mg}$     (B)  $\frac{F}{3mg}$     (C)  $\frac{F}{2mg}$     (D)  $\frac{F}{mg}$     (E)  $\frac{2mg}{F}$
- 
44. Consider a traveling wave on a string of length  $L$ , mass  $M$ , and tension  $T$ . A standing wave is set up. Which of the following is true?  
(A) The wave velocity depends on  $M, L, T$ .  
(B) The wavelength of the wave is proportional to the frequency.  
(C) The velocity of a given particle in the string is equal to the wave velocity.  
(D) The wavelength is proportional to  $T$ .  
(E) The frequency depends upon  $L$ .
45. A heat engine is operating between  $40^\circ\text{C}$  and  $380^\circ\text{C}$  and has an efficiency that is 60% of a Carnot engine that is operating between the same temperatures. If the engine absorbs heat at a rate of  $60 \text{ kW}$ , at what rate does it exhaust heat?  
(A)  $36 \text{ kW}$     (B)  $41 \text{ kW}$     (C)  $48 \text{ kW}$     (D)  $57 \text{ kW}$     (E)  $60 \text{ kW}$

46. In physics experiments located deep underground, the two types of cosmic rays that most commonly reach the experimental apparatus are:  
 (A) alpha particles and neutrons  
 (B) protons and electrons  
 (C) iron nuclei and carbon nuclei  
 (D) muons and neutrinos  
 (E) positrons and electrons
47. When two identical resistors are connected in series to an ideal voltage source, the current supplied by the source is 2.0 Amperes. When these two resistors are connected in parallel to the same ideal voltage source, what is the current supplied by the source?  
 (A) 0.5 Ampere      (B) 1.0 Ampere      (C) 2.8 Amperes      (D) 4.0 Amperes      (E) 8.0 Amperes
48. It is observed that a charged particle moves through a region of space and experiences no magnetic force. From this we can conclude that  
 (A) no magnetic field exists in that region of space.  
 (B) the particle is moving parallel to the magnetic field.  
 (C) the particle is moving perpendicular to the magnetic field.  
 (D) either no magnetic field exists or the particle is moving parallel to the magnetic field.  
 (E) either no magnetic field exists or the particle is moving perpendicular to the magnetic field.
49. A lump of clay whose rest mass is 4.0 kg is traveling at three-fifths of the speed of light when it collides head-on with an identical lump going in the opposite direction at the same speed. If the two lumps stick together and no energy is radiated away, what is the mass of the composite lump?  
 (A) 4.0 kg      (B) 6.4 kg      (C) 8.0 kg      (D) 10.0 kg      (E) 13.3 kg
50. One mole of ideal gas initially at temperature  $T_0$  and volume  $V_0$  undergoes a reversible isothermal expansion to  $V_1$ . If the ratio of specific heats is  $c_p/c_v = \gamma$  and if  $R$  is the gas constant, the work done by the gas is:  
 (A) Zero      (B)  $RT_0(V_1/V_0)^\gamma$       (C)  $RT_0(V_1/V_0 - 1)$       (D)  $C_v T_0 [1 - (V_0/V_1)^{\gamma-1}]$       (E)  $RT_0 \ln(V_1/V_0)$

**IMPORTANT: All Division 2 students STOP HERE.**  
**Your last answer should be for #50.**